



SINGLE CONTROL FAUCET

Z82200-XL-CP8

TAG _____



Engineering Specification: Zurn AquaSpec® Z82200-XL-CP8

Polished chrome plated cast brass single lavatory faucet with an integral 5" [127mm] cast spout, a ceramic disc cartridge and a temperature limit stop. Unit is furnished with a 2.2 GPM [8.3 L] pressure compensating aerator (Complying with ANSI A112.18.1 Standard for flow), a metal ADA compliant lever handle, cast brass chrome plated cover plate with 8" [204mm] centers, anti-rotation pins, stainless steel flex connection hoses, and mounting hardware.

Zurn Lead Compliant* "XL" products are a line of durable, high quality brass faucets and fixtures that are designed and manufactured to comply with state laws and local codes that mandate lead content levels. Zurn "XL" products are manufactured with *not more than 0.25% lead content when used with respect to wetted surfaces of pipes and pipe fittings, plumbing fitting and fixtures: California Health & Safety Code § 116875; Vermont 9 VCA § 2470h

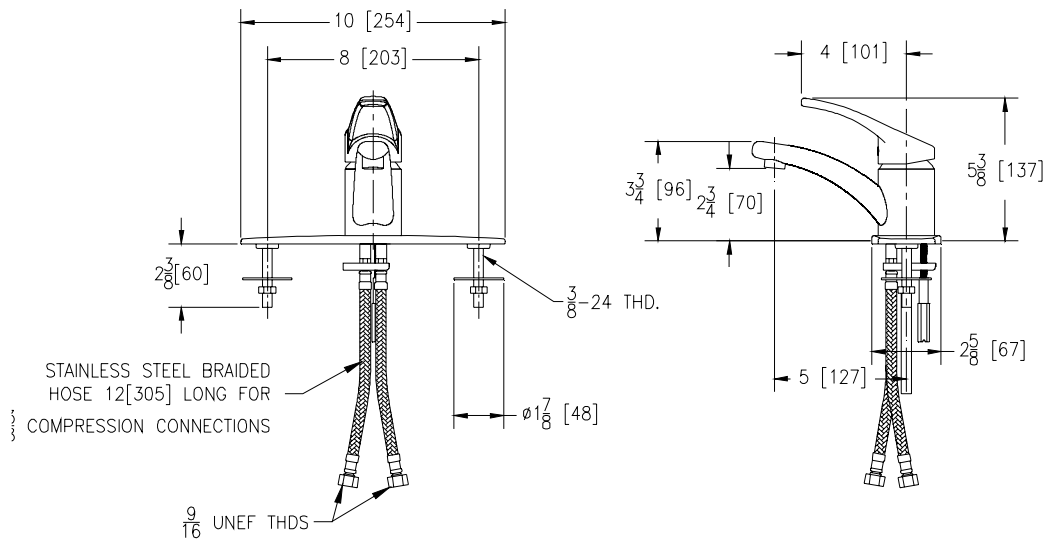

Note: All dimensions are for reference only. Do not use for pre-plumbing

OPTIONAL ACCESSORIES

Suffix	Description
___ -CP4	Chrome Plated 4" [102mm] Cover Plate
___ -CST	Copper Supply Tubes
___ -G	1-1/4" [32mm] Grid Strainer Drain
___ -P	1-1/4" [32mm] Pop-up Drain
___ -2M	2.2 GPM [8.3 L] Vandal-Resistant Pressure Compensating Male Aerator
___ -3M	.5 GPM [1.9 L] Vandal-Resistant Pressure Compensating Male Spray Outlet
___ -4M	2.2 GPM [8.3 L] Vandal-Resistant Pressure Compensating Male Laminar Flow Outlet
___ -7M	1.0 GPM [3.8 L] Pressure Compensating Male Spray Outlet
___ -16M	1.0 GPM [3.8 L] Vandal Resistant Pressure Compensating Male Spray Outlet
___ -17M	1.5 GPM [5.7 L] Vandal Resistant Pressure Compensating Male Aerator
___ -18FH	18" [457mm] S.S. Braided Flex Hoses
___ -18M	1.5 GPM [5.7 L] Vandal Resistant Pressure Compensating Male Laminar Flow
___ -19M	1.5 GPM [5.7 L] Anti-Microbial Pressure Compensating Male Laminar Flow Outlet
___ -21M	1.0 GPM [3.8L] Pressure Compensating Male Laminar Flow Outlet
___ -22M	1.0 GPM [3.8L] Pressure Compensating Vandal-Resistant Male Laminar Flow Outlet
___ -23M	1.5 GPM [5.7L] Pressure Compensating Male Aerator

ZURN INDUSTRIES, LLC ♦ COMMERCIAL BRASS OPERATION ♦ 2640 SOUTH WORK STREET ♦ FALCONER NY 14733

Phone: 1-800-997-3876 ♦ Fax: 1-919-775-3541 ♦ www.zurn.com

In Canada: ZURN INDUSTRIES LIMITED ♦ 3544 Nashua Drive ♦ Mississauga, Ontario L4V1L2 ♦ Phone: 905/405-8272 Fax: 905/405-1292